



MILLIPORE

Water Purification

Elix[®] 20/35/70/100



ADVANCING LIFE SCIENCE TOGETHER™
Research. Development. Production.



Pure Experience

In planning a water distribution loop that will meet desired flow rate and pressure needs, Millipore has the engineering expertise to determine the adequate pump size based on calculated piping and equipment pressure losses. To ensure that minimum flow velocity throughout the distribution loop will be achieved, Millipore follows strict design guidelines (by avoiding piping dead-legs, for example).

Millipore has over 40 years' experience in the development of products aimed at improving the quality and reliability of results; from research laboratories to QA/QC laboratories in the pharmaceutical industry. Based on this in-depth knowledge of diverse **laboratory applications and equipment, pharmaceutical industry requirements and water purification techniques**, Millipore provides a comprehensive package for total water purification systems for a single laboratory, a suite of laboratories or an entire laboratory building.

TOTAL PURE WATER SOLUTIONS

Millipore is the partner of choice for total water purification systems; from conception and design through to engineering expertise and technical support services.

Millipore works together with end-user scientists, architects, consultants, lab managers, facilities managers, contractors and equipment suppliers throughout a project to meet customers' specific requirements.

Total Performance

Determining the specific requirements for a laboratory, a suite of laboratories or an entire laboratory building is often the most difficult part of the project. From the earliest stages, Millipore professionals work with all parties, providing advice on key parameters such as water quality and quantity, standards that must be adhered to and considerations for long-term laboratory use.

Total Expertise

Millipore provides the expertise throughout the project to ensure that all components are designed and implemented according to strict guidelines – assuring users that the total water purification system will meet the expected performance levels.

Partnership

The partnership begins with each customer defining their own specific needs: the quality and quantities of water required, practical considerations and requirements for regulatory standards.

Design

Millipore can provide a specific configuration for a particular design or several options to meet the demands of regulatory bodies as well as valuable advice on choosing the best design to meet customer needs.

Installation

Millipore can provide the systems and all the necessary components and materials to perform the installation.

Support

For complete peace of mind, Millipore offers comprehensive qualification: Installation Qualification (IQ) and Operational Qualification (OQ), as well as maintenance programs for the water purification system.



A total water purification system requires the main water purification system to be integrated into a centralized system.

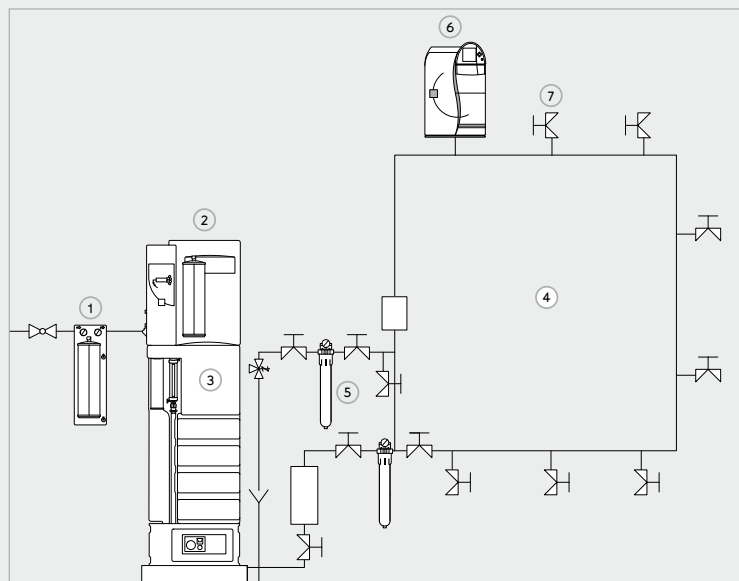

- ① Pretreatment
- ② Make-up water purification system (Elix system)
- ③ Storage reservoir
- ④ Distribution loop
- ⑤ Accessories (UV Lamp, Resistivity Monitor, Bacteria Filter, etc.)
- ⑥ Milli-Q system (point-of-use polisher)
- ⑦ Pure water point-of-use

USER NEEDS AND APPLICATIONS

Millipore has developed Elix systems for users requiring a few hundred liters per day up to several thousand liters per day of analytical-grade water. The Elix system is at the heart of the "Total Pure Water Solution." The system can be connected to additional components and accessories in order to build a comprehensive water purification system, designed and tailored to specific customer needs.

Pure analytical-grade water is required for a broad range of laboratory applications in a variety of industry sectors, including the:

- Pharmaceutical Industry
- Clinical Sector
- Chemical Industry
- Metallurgical Industry
- Cosmetics Industry
- Food and Beverage Industry
- Electronics Industry
- Biotech Industry

Analytical-grade water meets the specifications for Type II water defined by CAP, ISO® 3696 / BS 3997 and CLSI® and for Purified Water defined by the European and U.S. Pharmacopoeia. It is suitable for the following applications:

- Microbiological media preparation
- Buffer preparation
- Hydroponics
- Manufacturing chemical and biochemical reagents
- Pharmaceutical laboratory
- Feed to laboratory equipment: washing machines, clinical analyzers, stability chambers, humidifiers, autoclaves, weathering test equipment, hydrogen gas generators
- Feed water for Milli-Q® and Super-Q® ultrapure water systems

The Elix system can directly control the following external components:

- a distribution loop pump
- an in-line loop UV lamp
- an Automatic Sanitization Module (ASM) on the storage reservoir
- a water detector
- TOC and resistivity monitors
- an automatic loop drain valve
- an additional booster pump (if tap feed water pressure is not sufficiently high)

Elix Technology

Water passing through the Elix module is purified. At the same time ion-exchange resins in the module are continuously regenerated via an electrical current. This process requires only very small quantities of water and energy. No special maintenance or chemical regeneration is needed that would deteriorate the resin beads. This unique process has become the new standard for the production of pure water and is replacing both distillation and conventional deionization units in the laboratory.

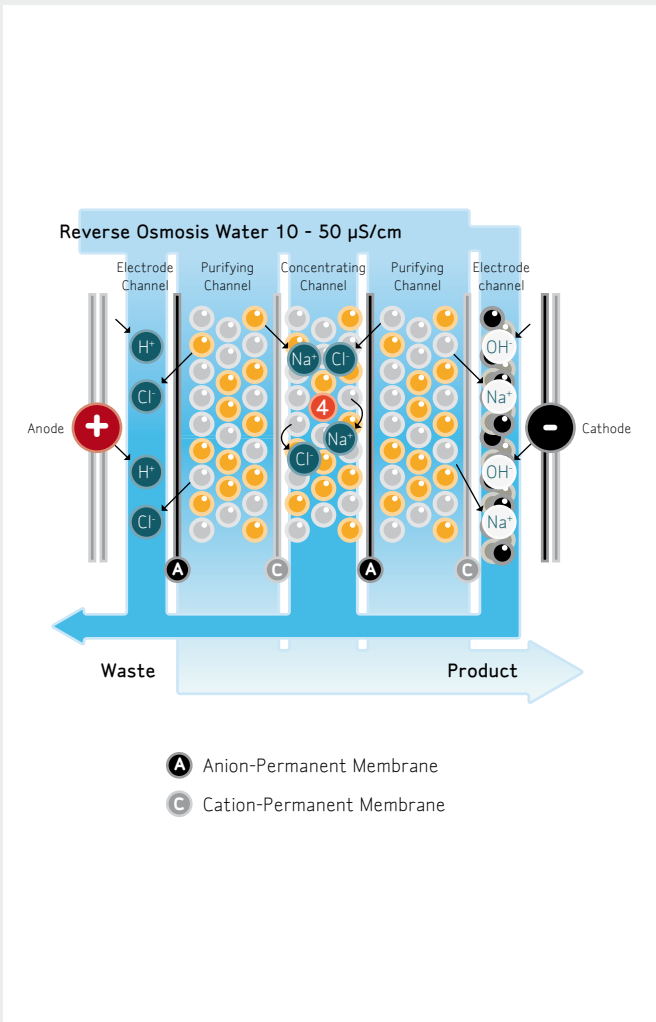

PRINCIPLE

- 1 Feed water enters the Elix module and splits into three types of flow channels: the electrode channels, the purifying channels and through the concentrating channels of resin beds sandwiched between anion- and cation-permeable membranes.
- 2 Electronic-grade, mixed-bed ion-exchange resin captures dissolved ions.
- 3 Electrical current across the module pulls captured cations through the cation-permeable membranes (C) towards the cathode, and anions through the anion-permeable membranes (A) towards the anode. Ion-exchange resins on both sides of the membrane enhance the transfer of ions through the cation and anion-permeable membranes.
- 4 Cation-permeable membranes prevent anions from proceeding towards the anode, and anion-permeable membranes prevent cations from proceeding towards the cathode. This results in a reduction in the ion concentration in the purifying channels.
- 5 Activated carbon beads next to the cathode avoid scaling issues by lowering the local pH at the electrode surface.
- 6 Ions in the concentrating channels are flushed from the system into the waste stream.
- 7 Purified water leaves the module.

Characteristics of Elix water

Resistivity	> 5 MΩ·cm* (typically 10 -15 MΩ·cm)
Conductivity	< 0.2 µS/cm* (typically 0.067 - 0.10 µS/cm)
Typical TOC	< 30 ppb
Bacterial count	< 10 cfu/ml

* [CO₂] < 30 ppm in feed water

One Complete Purification and Control Unit

Incorporating both the purification technologies as well as the overall control and monitoring functions for the total water purification system, the Elix system serves as the nerve center for the total water purification chain.

TOTAL CONTROL

Elix systems provide total control of all functions, operating parameters and standard accessory components

- within the Elix system itself
- within the external pure water distribution loop.

No external control box is normally required.

- Parameters and performances are controlled at each stage of the purification process to ensure water quality - including feed water conductivity, RO permeate conductivity, % rejection of the RO membranes, water temperature and operating pressure.
- Resistivity and TOC levels of Elix product water are monitored to ensure water quality; monitoring within the pure water distribution loop is also possible. [TOC and resistivity monitors are designed to be able to take into account the requirements of USP 29 <643> and <645> suitability tests].

CONTROLLING PURE WATER QUALITY – RESISTIVITY & TOC MONITORING

Resistivity

The accuracy of the measured water quality is guaranteed by the special design of the resistivity cell.

- Low cell constant (0.15 cm^{-1})
- Flow-through design
- Temperature measurement with a $0.1 \text{ }^\circ\text{C}$ resolution
- Automatic alert and alarms
- Resistivity meter is designed to be able to take into account the requirements of the USP 29 <645> suitability test.
- Water resistivity can be measured at the system outlet and in the distribution loop.

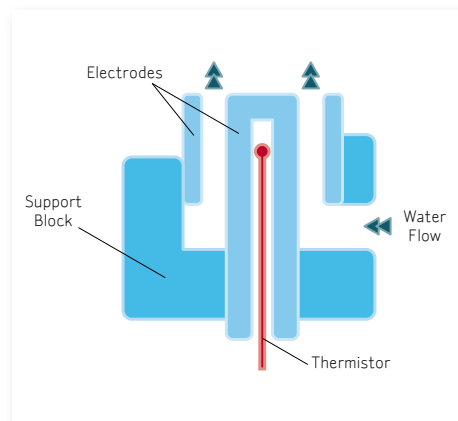

High Precision Coaxial Resistivity Cell

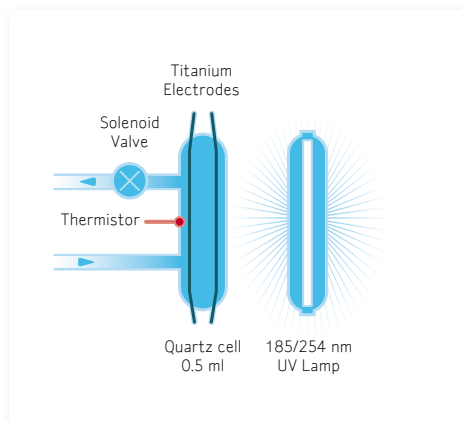

A10 TOC Monitor Photooxidation Cell

TOC (Total Oxidizable Carbon)

The built-in TOC monitor enables accurate TOC measurement from 1 to 999 ppb and has been designed to be able to take into account the requirements for the USP 29 <643> suitability test.

The TOC monitor works as follows:

- 1 The water to be tested is captured in a 0.5 ml oxidation cell.
- 2 The UV lamp in the TOC monitor causes photo-catalytic oxidation of the organic compounds to occur, resulting in an increase in conductivity.
- 3 The water conductivity is continuously monitored and temperature compensated to $25 \text{ }^\circ\text{C}$.
- 4 A set of algorithms confirms complete oxidation and calculates the ppb TOC level based on the conductivity change.

Inside the Elix System

The principal water purification takes place inside the Elix system itself. A combination of complementary purification technologies produces optimum quality analytical-grade water.

OPTIMIZED CONTROL OF WATER QUALITY

After each purification step, relevant parameters are checked by the system:

- Feed pressure, feed water quality
- RO pressure, RO water quality, RO membrane efficiency (% ion rejection)
- Elix water: resistivity, TOC* and temperature
- Water quality in the loop return (resistivity and/or TOC*) can also be checked by the system

*available as an option



PRETREATMENT

The Progard® TL pretreatment pack, the first step, removes:

- Particles (0.5 µm filter)
- Free chlorine and colloids (activated carbon filter) from tap water to protect the system.

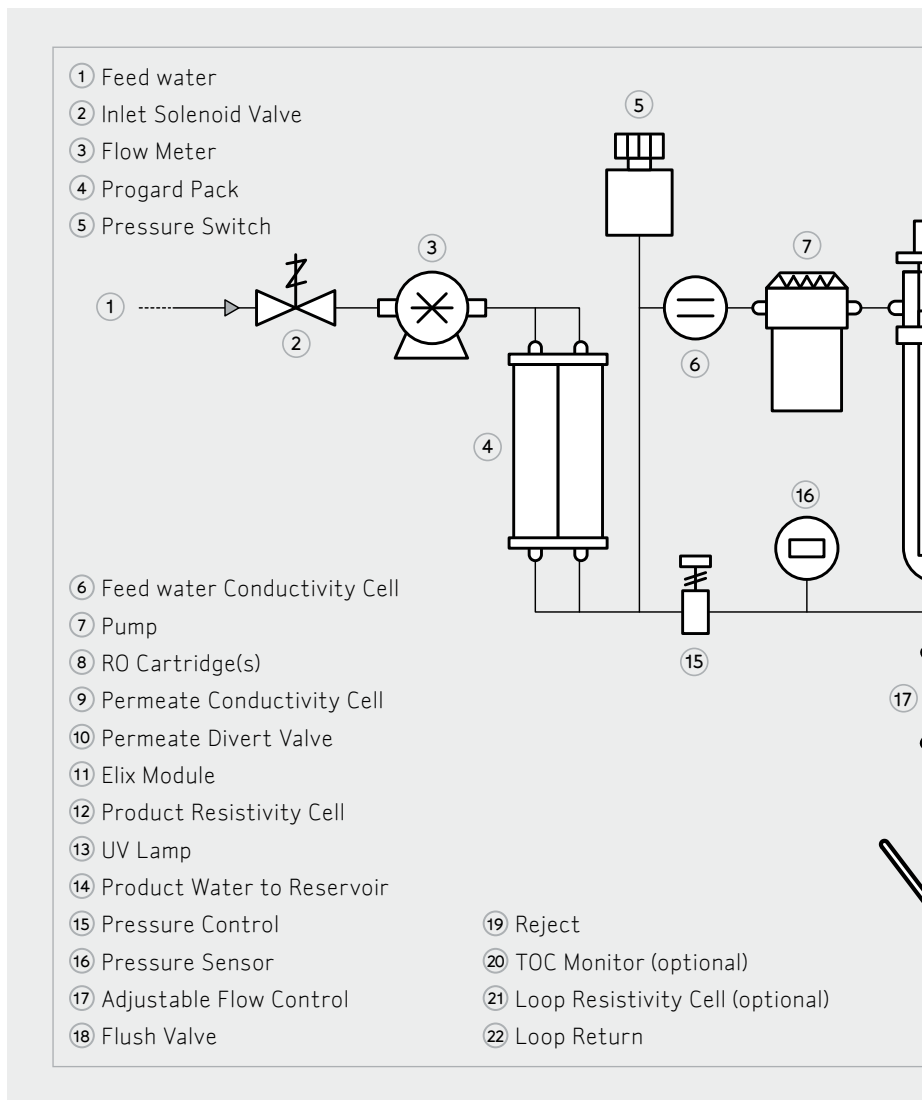

ADVANCED REVERSE OSMOSIS

Reverse Osmosis (RO), the second step, removes 95 - 99 % of ions and 99 % of all dissolved organics (MW >200 Dalton), micro-organisms and particles.

Built-in advanced features provide 2 major benefits:

- High water recovery: Part of the RO reject water is recycled back to the RO membrane feed water stream. Water recovery can be adjusted up to 70 % to optimize water consumption, depending on the feed water quality and the pretreatment used.
- Constant product flow rate: Elix systems maintain a constant flow rate from 7- 30 °C. Typically, standard RO-based systems suffer a decline in product flow rate of as much as 50 % as water temperature decreases.



MAXIMUM CONTROL OF DISTRIBUTION LOOP COMPONENTS

Integrated control functions for:

- The distribution pump
- UV lamp
- ASM on the storage reservoir
- TOC and resistivity monitoring in the distribution loop

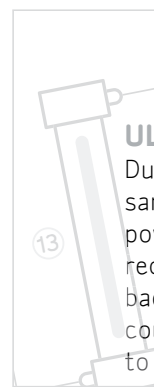
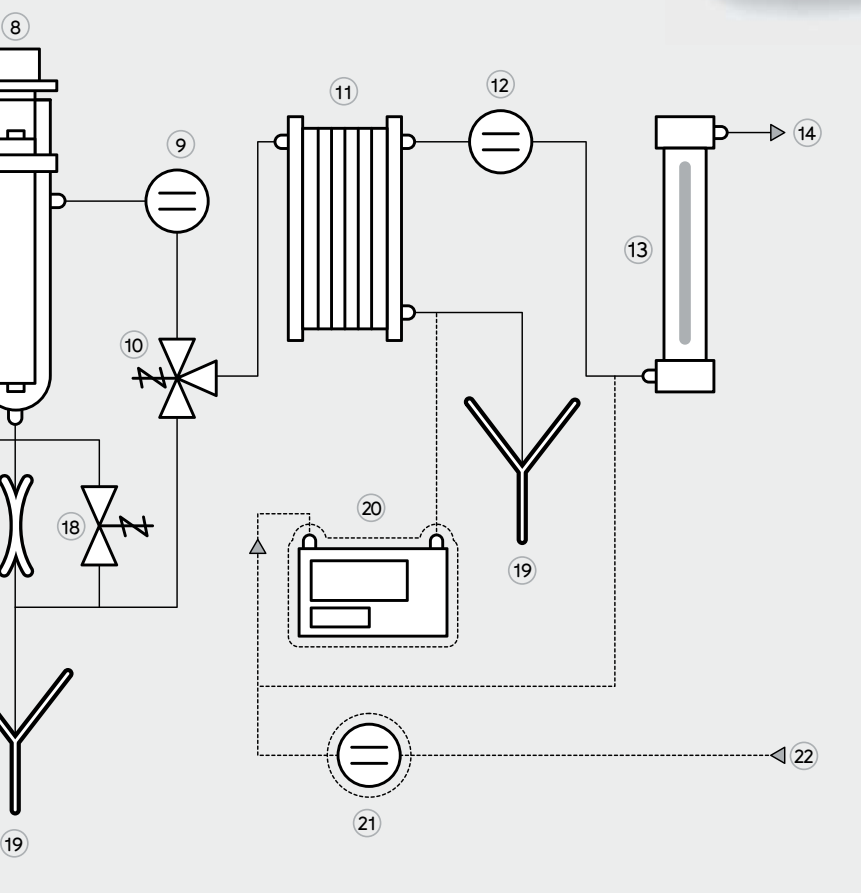

ULTRAVIOLET LAMP

During the last step, the water is sanitized by a 254 nm UV lamp. This powerful UV lamp leads to a log reduction value (LRV) of 4 in the bacterial count of the water (a bacterial count of 10,000 cfu/ml will be reduced to 1 cfu/ml), irrespective of the system's nominal flow rate. This allows the Elix system to produce optimum water quality for bacteria-sensitive applications.

ELIX MODULE

Millipore's patented Elix module, the third step, removes the remaining ions by electrodeionization.

(Detailed information on page 5).



- Ion-exchange resins are continuously regenerated by the electric field applied within the module – eliminating the need to interrupt water production for hazardous chemical regeneration or costly resin replacement.
- Resins are always of the highest quality: resins do not degrade as they are not exposed to harsh regeneration chemicals or moved outside the system.

Easy Maintenance and Low Running Costs

- No additional softeners are required for most feed water conditions due to Millipore's patented Elix module (advanced electrodeionization).
- The Elix module continuously regenerates ion-exchange resins – no expensive replacement is necessary.
- Water saving with the RO-reject water recirculation loop.
- Adjustable RO percent recovery optimizes running conditions.
- Easy-to-replace pretreatment packs, tailored to the feed water source.



Ease-of-Use

The Elix system has been designed for minimum maintenance. Each purification step contains specific features which make the systems easy to use and are designed to help users working in GMP/GLP environments.

- Automatic sanitization of the RO module is performed when the pretreatment pack is changed.
- Automatic flush and rinsing cycles avoid stagnation of the water inside the system during periods when not in use.
- The Elix module is self-maintaining.
- All operating modes, performance parameters and indicators for routine maintenance are displayed (available in 6 different languages).
- When service and/or maintenance is required, this is clearly indicated by a message on the system display and a flashing red or yellow LED indicator, depending on the intervention required.

Total Service and Support

From each stage of the project (conception, design and installation) to everyday use, Millipore offers comprehensive, high-quality support services.

DESIGN SUPPORT

Millipore helps design your water purification system installation. This includes the make-up water purification system as well as the storage, distribution and control systems. Millipore's engineering group has a broad range of products available installation service, and also offer training and advice on how to optimize the use of your system.

INSTALLATION & TRAINING SUPPORT

Millipore Field Service Support Engineers provide an efficient system installation service, and also offer training and advice on how to optimize the use of your system.

USER SUPPORT

Millipore's Field Service Support Engineers and Technical Service Specialists are available to answer any questions you may have on your water purification system. Our specialized team is always ready to help. Because preventive maintenance is the most efficient and reliable way to ensure optimum water quality over the long term, our specialists offer service plans designed to match your requirements: regular maintenance, rapid intervention and customized services such as verification of water quality monitoring devices.

QUALIFICATION SUPPORT - COMPLIANCE WITH STANDARDS

Millipore has over 10 years' of qualification experience, having performed thousands of qualification protocols, using calibrated devices and specific test equipment developed for our systems. Our certified Field Service Support Engineers offer assistance to help you successfully perform your Installation Qualification, Operational Qualification and maintenance program within a GMP and/or GLP environment.



Specifications

FEED WATER REQUIREMENTS

Quality	Potable Mains (Tap) Water
Conductivity	< 2000 $\mu\text{S}/\text{cm}$ (@ 25 °C)
pH	4-10
Maximum LSI	< 0.3
Calcium (as CaCO_3)	< 300 ppm (when system water recovery > 50 %)
Total Chlorine level	Millipore Application Specialist will determine pretreatment required
Fouling index	Millipore Application Specialist will determine pretreatment required
Feed water pressure	2 bar minimum, 6 bar maximum (29 psi min, 86 psi max)
Flow rate	> 5 l/min at 2 bar (1.3 gal/min at 29 psi)

SYSTEM PERFORMANCE

	Elix 20	Elix 35	Elix 70	Elix 100
Product flow rate (nominal flow rates, 7 to 30 °C)	20 l/h 5.3 gal/h	35 l/h 9.2 gal/h	70 l/h 18.5 gal/h	100 l/h 26.4 gal/h
Water recovery (Millipore Application Specialist will optimize recovery based on feed water and pretreatment)	up to 30 %	up to 40 %	up to 50 %	up to 50 %
Product water resistivity* (compensated to 25 °C)	> 5 $\text{M}\Omega\cdot\text{cm}$ typically 10-15 $\text{M}\Omega\cdot\text{cm}$	> 5 $\text{M}\Omega\cdot\text{cm}$ typically 10-15 $\text{M}\Omega\cdot\text{cm}$	> 5 $\text{M}\Omega\cdot\text{cm}$ typically 10-15 $\text{M}\Omega\cdot\text{cm}$	> 5 $\text{M}\Omega\cdot\text{cm}$ typically 10-15 $\text{M}\Omega\cdot\text{cm}$
Product water conductivity* (compensated to 25 °C)	< 0.2 $\mu\text{S}/\text{cm}$ typically 0.067-0.10 $\mu\text{S}/\text{cm}$	< 0.2 $\mu\text{S}/\text{cm}$ typically 0.067-0.10 $\mu\text{S}/\text{cm}$	< 0.2 $\mu\text{S}/\text{cm}$ typically 0.067-0.10 $\mu\text{S}/\text{cm}$	< 0.2 $\mu\text{S}/\text{cm}$ typically 0.067-0.10 $\mu\text{S}/\text{cm}$
Product water TOC	< 30 ppb	< 30 ppb	< 30 ppb	< 30 ppb
Bacteria	< 10 cfu/ml	< 10 cfu/ml	< 10 cfu/ml	< 10 cfu/ml
Silica rejection	> 99.9 %	> 99.9 %	> 99.9 %	> 99.9 %

* [CO_2] < 30 ppm in feed water: typically 10-15 $\text{M}\Omega\cdot\text{cm}$

GENERAL SPECIFICATIONS

Water connections	
Solenoid valve feed	½- in NPTM or 1/2-in M-GAZ
System feed	½- in tubing
Product	8 mm tubing
RO reject	½- in tubing
Elix module reject	8 mm tubing
Electrical requirements	
	- 117 V/60 Hz, 10 A, (10 A Slo-Blo® fuse)
	- 230 V/50 Hz, 5 A, (10 A Slo-Blo fuse)
	- 110 V/50/60 Hz, 10 A, (10 A Slo-Blo fuse)
Data port connection	RS232
Drain requirements	> 5 l/min (> 1.3 gal/min)
Dimensions (H x W x D)	733 mm x 662 mm x 441 mm (28.9 x 26.1 x 17.4 in) additional 47 mm (1.8 in) width required for plumbing connections



System operating weight	
Elix 20	45 kg (99 lbs)
Elix 35	48 kg (106 lbs)
Elix 70	56 kg (123 lbs)
Elix 100	62 kg (137 lbs)

Millipore offers more innovative technologies and stronger application support to streamline processes and provide consistently reliable results. Our Lab Water experts take the time to evaluate the needs of individual labs and particular applications in order to recommend a system that balances water quality with volume and distribution requirements, removing water quality concerns so customers can focus on their research.



www.millipore.com/offices